











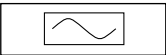
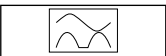
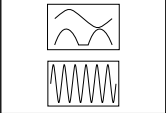

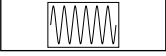
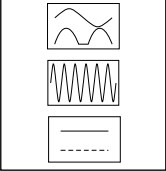
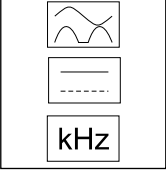
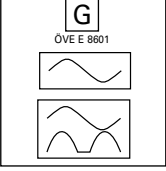
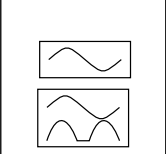
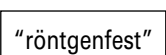
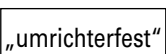















**Residual Current Devices - General Data**

**Short description of the most important RCD types**

Symbol	Description
	Eaton standard. Suitable for outdoor installation (distribution boxes for outdoor installation and building sites) up to -25° C.
	Conditionally surge-current proof (>250 A, 8/20 µs) for general application.
	Type AC: AC current sensitive RCCB
	Type A: AC and pulsating DC current sensitive RCCB, not affected by smooth DC fault currents up to 6 mA
	Type F: AC and pulsating DC current sensitive RCCB, trips also at frequency mixtures (10 Hz, 50 Hz, 1000 Hz), min. 10 ms time-delayed, min. 3 kA surge current proof, higher load capacity with smooth DC fault currents up to 10 mA
	Frequency range up to 20 kHz
	Trips also at frequency mixtures (10 Hz, 50 Hz, 1000 Hz)
	Type B: All-current sensitive RCD switchgear for applications where DC fault currents may occur. Non-selective, non-delayed. Protection against all kinds of fault currents.
	Type B+: All-current sensitive RCD switchgear for applications where DC fault currents may occur. Non-selective, non-delayed. Protection against all kinds of fault currents. Provides enhanced fire safety.
	RCD of type G (min 10 ms time delay) surge current-proof up to 3 kA. For system components where protection against unwanted tripping is needed to avoid personal injury and damage to property. Also for systems involving long lines with high capacitive reactance. Some versions are sensitive to pulsating DC. Some versions are available in all-current sensitive design.
	RCD of type S (selective, min 40 ms time delay) surge current-proof up to 5 kA. Mainly used as main switch, as well as in combination with surge arresters. This is the only RCD suitable for series connection with other types if the rated tripping current of the downstream RCD does not exceed one third of the rated tripping current of the device of type S. Some versions are sensitive to pulsating DC. Some versions are available in all-current sensitive design.
	„X-ray-proof“, for avoiding unwanted tripping caused by x-ray devices.
	„Frequency converter-proof“, for avoiding unwanted tripping caused by frequency converters, speed-controlled drives, etc.

### Kind of residual current and correct use of RCD Types

Kind of current	Current profile	Correct use / application field of RCCB types						Tripping current
		AC	A	F	B	/ B+		
Sinusoidal AC residual current							0.5 to 1.0 $I_{\Delta n}$	
Pulsating DC residual current (positive or negative half-wave)		-					0.35 to 1.4 $I_{\Delta n}$	
Cut half-wave current		-					Lead angle 90°: 0.25 to 1.4 $I_{\Delta n}$ Lead angle 135°: 0.11 to 1.4 $I_{\Delta n}$	
Half-wave with smooth DC current of 6 mA		-					max. 1.4 $I_{\Delta n}$ + 6 mA	
Half-wave with smooth DC current of 10 mA		-	-				max. 1.4 $I_{\Delta n}$ + 10 mA	
Smooth DC current		-	-	-			0.5 to 2.0 $I_{\Delta n}$	

### Tripping time

#### Break time and non-actuating time for alternating residual currents (r.m.s. values) for type AC and A RCCB

Classification	$I_{\Delta n}$ mA		$I_{\Delta n}$	$2xI_{\Delta n}$	$5xI_{\Delta n}$	$5 x I_{\Delta n}$ or 0.25A	500A
Standard RCD Conditionally surge current-proof 250 A	≤30	Max. tripping time (s)	0.3	0.15		0.04	0.04
Standard RCD Conditionally surge current-proof 250 A	>30	Max. tripping time (s)	0.3	0.15	0.04		0.04
RCCB Type G (Short-time-delay) Surge current-proof 3 kA	30	Min. non actuating time(s) Max. tripping time (s)	0.01 0.3	0.01 0.15		0.01 0.04	0.01 0.04
RCCB Type G (Short-time-delay) Surge current-proof 3 kA	>30	Min. non actuating time(s) Max. tripping time (s)	0.01 0.3	0.01 0.15	0.01 0.04		0.01 0.04
RCCB Type S (Selective) Surge current-proof 5 kA	>30	Min. non actuating time(s) Max. tripping time (s)	0.13 0.5	0.06 0.2	0.05 0.15		0.04 0.15

#### Break time for half-wave pulsating residual currents (r.m.s. values) for type A RCCB

Classification	$I_{\Delta n}$ mA		$1.4xI_{\Delta n}$	$2xI_{\Delta n}$	$2.8xI_{\Delta n}$	$4xI_{\Delta n}$	$7 x I_{\Delta n}$ 0.35 A	0.5 A	350A
Standard RCD Conditionally surge current-proof 250 A	<30	Max. tripping time (s)		0.3		0.15		0.04	0.04
Standard RCD Conditionally surge current-proof 250 A	30	Max. tripping time (s)	0.3		0.15		0.04		0.04
Standard RCD Conditionally surge current-proof 250 A	>30	Max. tripping time (s)	0.3		0.15		0.04		0.04
RCCB Type G (Short-time-delay) Surge current-proof 3 kA	30	Max. tripping time (s)	0.3		0.15		0.04		0.04
RCCB Type G (Short-time-delay) Surge current-proof 3 kA	>30	Max. tripping time (s)	0.3		0.15		0.04		0.04
RCCB Type S (Selective) Surge current-proof 5 kA	>30	Max. tripping time (s)	0.5		0.2		0.15		0.15

**Tripping Characteristics (IEC/EN 61008)**

**Tripping characteristics, tripping time range and selectivity of instantaneous, surge current-proof „G“ and surge current-proof - selective „S“ residual current devices.**

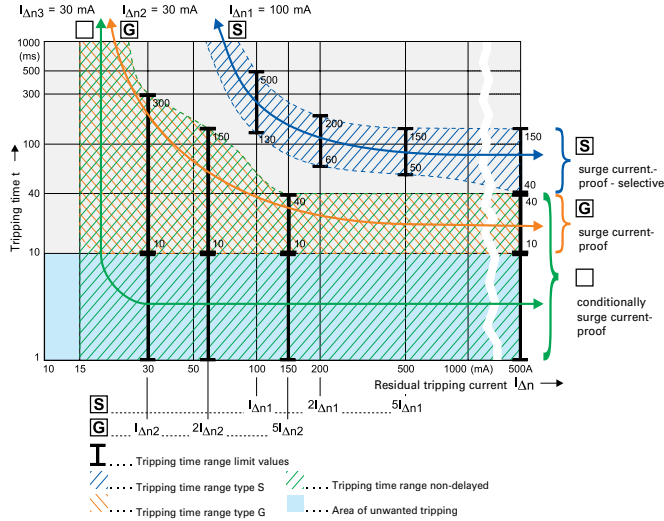

**IEC 60364-4-41** deals with additional protection: The use of RCDs with a rated residual operating current not exceeding 30 mA, is recognized in a.c. systems as additional protection in the event of failure of the provision for basic protection and/or the provision for fault protection or carelessness by users.

**This means when using RCDs for fault current/residual current protection two RCDs must be connected in series.**

**Testing:**

RCDs with tripping time delay (Types -G and -S) may be function tested with conventional testing equipment which must be set according to the instructions for operation of the testing device. Due to reasons inherent in the measuring process, the tripping time determined in this way may be longer than expected in accordance with the specifications of the manufacturer of the measuring instrument.

However, the device is ok if the result of measurement is within the time range specified by the manufacturer of the measuring instrument.

### Hints for the application of our frequency converter-proof RCDs:

Due to the currents flowing off through the filters (designated  $I_F$ ), the sum of currents through the RCD is not exactly zero, which causes unwanted tripping.

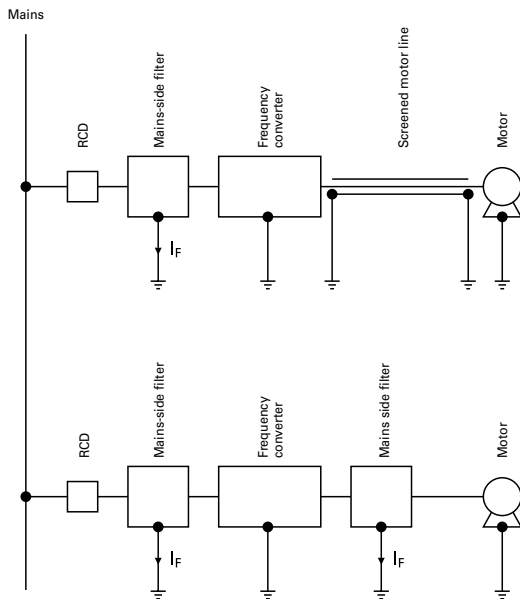

### Tripping characteristic

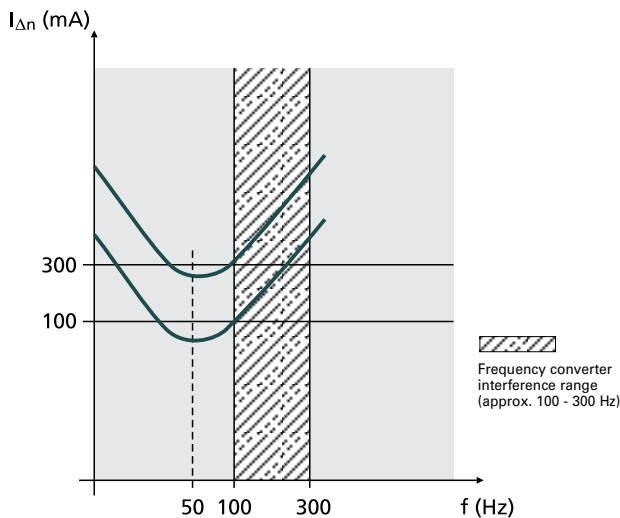

Frequency converters are used in a wide variety of systems and equipment requiring variable speed, such as lifts, escalators, conveyor belts, and large washing machines. Using them for such purposes in circuits with conventional residual current devices causes frequent problems with unwanted tripping.

The technical root cause of this phenomenon is the following: Fast switching operations involving high voltages cause high interference levels which propagate through the lines on the one hand, and in the form of interfering radiation on the other. In order to eliminate this problem, a mains-side filter (also referred to as input filter or EMC-filter) is connected between the RCD and frequency converter. The anti-interference capacitors in the filters produce discharge currents against earth which may cause unwanted tripping of the RCD due to the apparent residual currents. Connecting a filter on the output side between frequency converter and 3-phase AC motor results in the same behaviour.

This sample tripping characteristic of a 100 mA RCD and a 300 mA RCD shows the following: In the frequency range around 50 Hz, the RCDs trip as required (50 - 100 % of the indicated  $I_{\Delta n}$ ). In the range shown hatched in the diagram, i. e. from approx. 100 to 300 Hz, unwanted tripping occurs frequently due to the use of frequency converters. Frequency converter-proof residual current devices are much less sensitive in this frequency range than in the 50 - 60 Hz range, which leads to an enormous increase in the reliability of systems.

**Therefore, we recommend to use RCDs designed for applications with frequency converter!**

These special residual current devices can be recognised by an extension of the type designation („-F“). They meet the requirements of compatibility between RCDs and frequency converters with respect to unwanted tripping.

These are **NOT AC/DC-sensitive** (IEC 62423) RCDs of type B !!!

Our RCDs of type „-F“ are characterised by **SENSITIVITY TO RESIDUAL PULSATING DC** and **SELECTIVITY** or **SHORT-TIME DELAY**

## Specifications | Residual Current Devices FRCmM

### Description

- Residual current devices
- Shape compatible with and suitable for standard busbar connection to other devices of the xEffect-series
- Twin-purpose terminal (lift/open-mouthed) above and below
- Busbar positioning optionally above or below
- Free terminal space despite installed busbar
- Universal tripping signal switch, also suitable for FAZ, FRBmM-1N can be mounted subsequently
- Auxiliary switch Z-HK can be mounted subsequently
- Contact position indicator red - green
- Delayed types suitable for being used with standard fluorescent tubes with or without electronical ballast (30mA-RCD: 30 units per phase conductor, 100mA-RCD: 90 units per phase conductor).  
Notes: Depending of the fluorescent lamp ballast manufacturer partly more possible. Symmetrical allocation of the fluorescent lamp ballasts on all phases favourably. Shifting references of the fluorescent lamp ballast manufacturer consider.
- The device functions irrespective of the position of installation
- Tripping is line voltage-independent. Consequently, the RCD is suitable for "fault current/residual current protection" and "additional protection" within the meaning of the applicable installation rules.
- Mains connection at either side
- The 4-pole device can also be used for 2- or 3-pole connection:  
See connection possibilities.
- The test key "T" must be pressed every 6 months. The system operator must be informed of this obligation and his responsibility in a way that can be proven (self-adhesive RCD-label enclosed). Under special conditions (e.g. damply and/or dusty environments, environments with polluting and/or corroding conditions, environments with large temperature fluctuations, installations with a risk of overvoltages due to switching of equipment and/or atmospheric discharges, portable equipment ...), it's recommended to test in monthly intervals.
- Pressing the test key "T" serves the only purpose of function testing the residual current device (RCD). This test does not make earthing resistance measurement ( $R_E$ ), or proper checking of the earth conductor condition redundant, which must be performed separately.

- **Type -A:** Protects against special forms of residual pulsating DC which have not been smoothed.
- **Type -G:** High reliability against unwanted tripping. Suitable for any circuit where personal injury or damage to property may occur in case of unwanted tripping.
- **Type -G/A:** Additionally protects against special forms of residual pulsating DC which have not been smoothed.
- **Type -R:** To avoid unwanted tripping due to X-ray devices.
- **Type -S:** Selective residual current device sensitive to AC, Type -S. Suitable for systems with surge arresters downstream of the RCD.
- **Type -S/A:** Additionally protects against special forms of residual pulsating DC which have not been smoothed.
- **Type -U:** Suitable for speed-controlled drives with frequency converters in household, trade, and industry.  
Unwanted tripping is avoided thanks to a tripping characteristic designed particularly for frequency converters.

### Accessories:

Auxiliary switch for subsequent installation to the left	Z-HK	248432
Tripping signal contact for subsequent installation to the right	Z-NHK	248434
Automatic restarting device	Z-FW/LP	248296
	Z-FW-LPD	265244
Remote control	Z-FW-MO	284730
Pre-mounted sets	Z-FW-LP/MO	290171
	Z-FW-LPD/MO	290172
Remote testing module	Z-FW/003	248298
	Z-FW/010	248299
	Z-FW/030	248300
	Z-FW/050	248301
Terminal cover 4-poles	Z-RC/AK-4TE	101062

**Technical Data**

		<b>FRCmM</b>
<b>Electrical</b>		
Design according to		IEC/EN 61008 Type G acc. to ÖVE E 8601 IEC 61373, EN 45545-2
Classified according to		
Current test marks as printed onto the device		
Tripping		instantaneous
Type G , R		10 ms delay @ 50 Hz
Type S		40 ms delay @ 50 Hz - with selective disconnecting function
Type U (only 30 mA)		10 ms delay @ 50 Hz
Type U (except 30 mA)		40 ms delay @ 50 Hz - with selective disconnecting function
Rated voltage	$U_n$	240/415 V AC 50 Hz and/or 60 Hz – see individual article for operating frequency
Limits operation voltage test circuit		
2-poles		196 - 264 V~
4-poles 30 mA		196 - 264 V~
4-poles 30 mA -400		353 - 456 V~
4-poles 100, 300, 500 mA		196 - 456 V~
Rated tripping current	$I_{\Delta n}$	30, 100, 300, 500 mA
Sensitivity		AC and pulsating DC
Rated insulation voltage	$U_i$	440 V
Rated impulse withstand voltage	$U_{imp}$	4 kV (1.2/50µs)
Rated short circuit capacity	$I_{cn}$	10 kA with back-up fuse
Peak withstand current		
Type AC, A		250 A (8/20 µs) surge current-proof
Type G, G/A		3 kA (8/20 µs) surge current-proof, 10 ms delay
Type S, S/A		5 kA (8/20 µs) surge current-proof, 40 ms delay
Rated breaking capacity or rated fault breaking capacity	$I_m$ $I_{\Delta m}$	
$I_n = 16-40 A$		500 A
$I_n = 63 A$		630 A
$I_n = 80 A$		800 A
$I_n = 100 A$		1,000 A
Endurance		
electrical components		≥ 4,000 operating cycles
mechanical components		≥ 20,000 operating cycles
<b>Mechanical</b>		
Frame size		45 mm
Device height		80 mm
Device width		35 mm (2MU), 70 mm (4MU)
Mounting		quick fastening with 2 lock-in positions on DIN rail IEC/EN 60715
Degree of protection, built-in		IP40
Degree of protection in moisture-proof enclosure		IP54
Upper and lower terminals		open mouthed/lift terminals
Terminal protection		finger and hand touch safe, DGUV VS3, EN 50274
Terminal capacity		1.5 - 35 mm <sup>2</sup> single wire 2 x 16 mm <sup>2</sup> multi wire
Terminal screw		M5 (with slotted screw acc. to EN ISO 4757-Z2, Pozidriv PZ2)
Terminal torque		2 - 2.4 Nm
Busbar thickness		0.8 - 2 mm
Operation temperature		-25°C to +40°C (for higher values see table on ambient temperature)
Storage- and transport temperature		-35°C to +60°C
Resistance to climatic conditions		acc. to IEC/EN 61008
Contact position indicator		red / green
Tripping indicator		white / blue

### Connection diagram

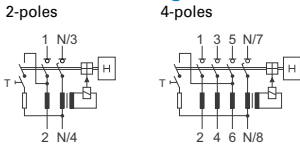

### Dimensions (mm)

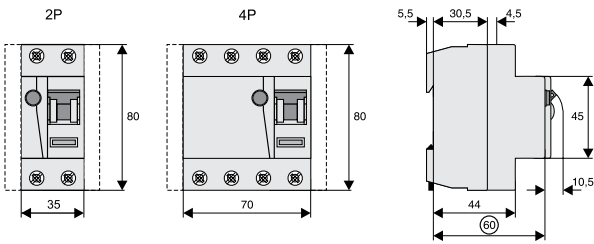

### Connection of ring cable lugs (only FRC...RT)

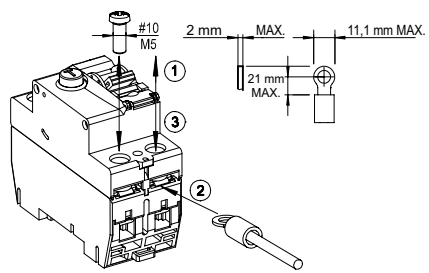

### Correct connection

#### 2-poles

30, 100, 300, 500mA Types:

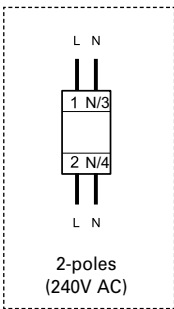

#### 4-poles

30mA -400 Types:

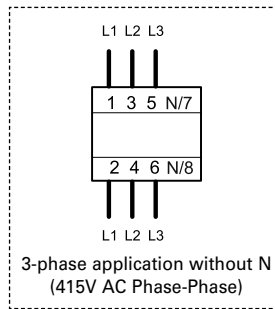

#### 4-poles

30mA Types:

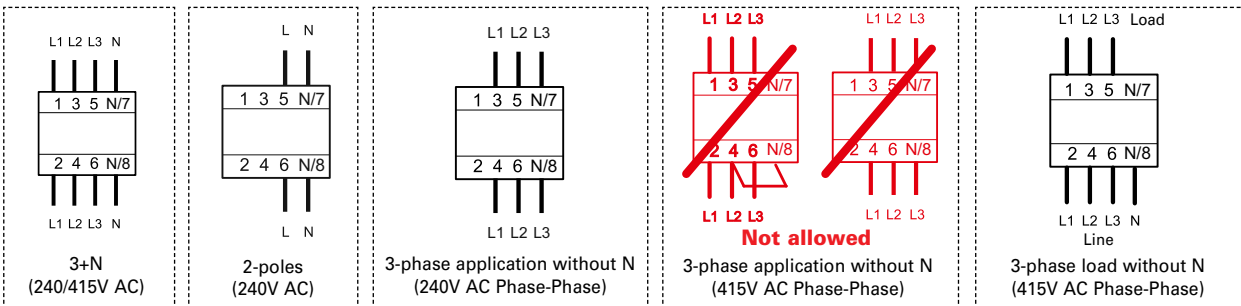

100, 300, 500mA Types:

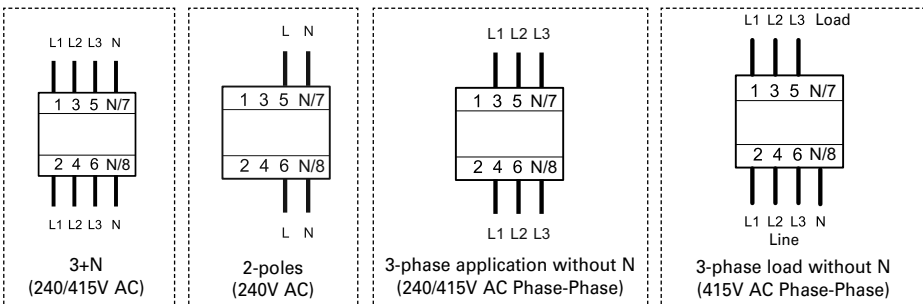

**Power Loss at  $I_n$  FRCmM**

(entire unit)

**Tripping: AC**

$I_n$ [A]	$I_{\Delta n}$ [mA]	P [W]
<b>2-poles</b>		
16	10	2.9
25	30	2.0
25	100, 300, 500	1.3
40	30	7.8
40	100, 300, 500	5.5
63	30	9.7
63	100, 300, 500	7.2
80	30	13.5
80	100, 300, 500	8.6
100	30, 100, 300	13.6
<b>4-poles</b>		
25	30	3.1
25	100, 300, 500	2.8
40	30	13.1
40	100, 300, 500	8.8
63	30	13.4
63	100, 300, 500	10.5
80	30, 100, 300, 500	11.4
100	30, 100, 300, 500	18.8

**Tripping: A**

$I_n$ [A]	$I_{\Delta n}$ [mA]	P [W]
<b>2-poles</b>		
16	10	2.9
16	30	1.2
25	30	2.0
25	100, 300	1.3
40	30	7.8
40	100, 300, 500	5.5
63	30	9.7
63	100, 300, 500	7.2
100	30, 100, 300	13.6
<b>4-poles</b>		
25	30	3.1
25	100, 300, 500	2.8
40	30	13.1
40	100, 300, 500	8.8
63	30, 100, 300, 500	10.5
80	30, 300	11.4
100	30, 100, 300, 500	18.8

**Tripping: G, G/A**

$I_n$ [A]	$I_{\Delta n}$ [mA]	P [W]
<b>2-poles</b>		
25	30, 100 (G)	2.0
40	30, 100 (G)	7.8
<b>4-poles</b>		
40	30 (G)	13.1
40	100 (G, G/A)	8.8
40	30 (G/A)	13.1
63	30 (G)	13.4
63	100 (G, G/A)	10.5
63	30 (G/A)	13.4
100	30, 300 (G/A)	18.8

**Tripping: S, S/A**

$I_n$ [A]	$I_{\Delta n}$ [mA]	P [W]
<b>2-poles</b>		
40	100 (S, S/A)	7.8
40	300 (S)	5.5
<b>4-poles</b>		
25	100, 300 (S)	2.8
25	100 (S/A)	2.8
40	100, 300 (S, S/A)	8.8
63	100, 300 (S)	10.5
63	100, 300 (S/A)	10.5
80	100, 300 (S)	11.4
80	300 (S/A)	11.4
100	300 (S/A)	18.8

**Tripping: R, U**

$I_n$ [A]	$I_{\Delta n}$ [mA]	P [W]
<b>4-poles</b>		
40	100, 300 (U)	8.4
63	30 (R)	13.4
63	100, 300 (U)	10.5
100	300 (U)	18.8



**Impact of ambient temperature on the maximum permanent current allowed (A) FRCmM**

Ambient temperature	25A		40A		63A		80A		100A	
	2p	4p	2p	4p	2p	4p	2p	4p	2p	4p
40°	25	25	40	40	63	63	80	80	100	100
45°	21	22	37	37	59	59	76	76	95	95
50°	18	19	33	34	55	55	72	72	90	90
55°	14	16	30	31	50	50	68	68	85	85
60°	–	–	26	27	45	45	64	64	80	80
65°	–	–	20	24	40	41	60	60	75	75
70°	–	–	14	19	34	37	56	56	70	70
75°	–	–	8	15	28	32	52	52	65	65

Note: Please make sure that these values are not exceeded and that any upstream thermal overload protection switches off in time.

**Max. back-up fuse FRCmM**

Rating In [A]	Fuses		MCB's (Characteristic B/C)	
	Short Circuit [A]	Overload [A]	Short Circuit [A]	Overload [A]
25	63 gG/gI	25 gG/gI	FAZ-C40	FAZ-C25
40	63 gG/gI	40 gG/gI	FAZ-C40	FAZ-C40
63	63 gG/gI	63 gG/gI	FAZ-C40	FAZ-C40
80	80 gG/gI	80 gG/gI	-	-
100	100 gG/gI	80 gG/gI	-	-

**Important:**

In the case that the maximal possible operating current of the electrical installation don't exceed the rated current of the RCD only short circuit protection must be implemented. Overload protection must be implemented in the case if the maximal possible operating current of the electrical installation can exceed the rated current of the RCD.